

Impedance Measurements in Cell Cultures on Polymer Slides

¹Jäger, M.; ²Sonntag, F.; ¹Zaunseder, S.; ¹Poll, R.; ²Klotzbach, U.; ¹Rabenau, M.

¹Technical University Dresden, Institute of Biomedical Engineering
Helmholtzstr. 10, 01069 Dresden

²Fraunhofer Institute for Material and Beam Technology IWS
Winterbergstr. 28, 01277 Dresden

martin.jaeger@mailbox.tu-dresden.de

Abstract

The research objective is an optimized and tested, easily operated measuring procedure for monitoring of cell cultures by means of impedance measurement, which can be adapted individually to scientific requirements. As one application example, the adhesion and development of cells on surface-modified polymer slides are to be examined with this method.

Introduction

Biological impedance measurement methods have been focused in medical research recently. The evaluation of passive electrical characteristics of biological systems is a simple and reasonable method for the characterization of biological tissues and cell structures [1]. In vitro studies with cell cultures provide knowledge for therapeutic, diagnostic and pharmaceutical applications. Due to their complex functionality cell cultures establish new possibilities for complex chemical or biological verification methods [2]. Thus it is possible to dissolve changes temporally and locally, to detect simultaneously rare or several substances and to hedge the measurement statistically. Complex test preparation steps can be carried out by the cells themselves. The analysis of different cell parameters and vital functions are usually made by fluorescence-optical procedures, which limit the tests temporally, due to the additives used in these procedures.

The fact that cells are not influenced or damaged, due to a suitable choice of the measuring parameters distinguishes impedance technologies in comparison to many optical investigation methods. The application of the impedance spectroscopy allows an on-line observation of cell cultures for a longer period. Basic statements to the current morphologic cell state and growth conditions can be made.

Furthermore the automatization of such methods is by far easier to realize. This is of use during the monitoring of cell cultures, for example. In addition, advanced studies showed, that hardly accessible parameters such as the distance between adhered cells and a substrate could be attained by impedance spectroscopy. Thus the use of impedance-based research methods generally represents a very promising technology.

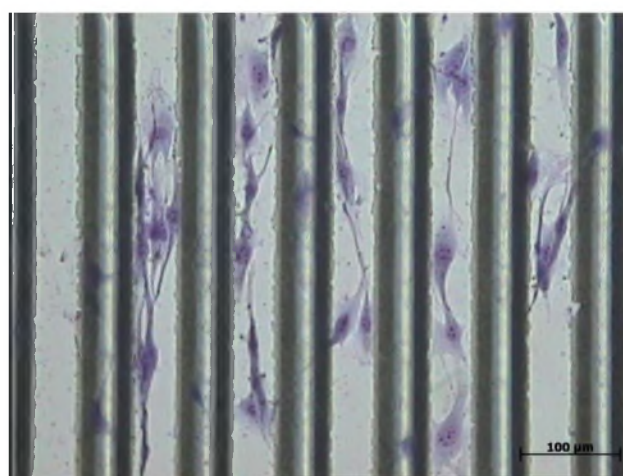

Figure 1: Cell growth of M2-10B4 fibroblasts is influenced by laser-made cell guidance structures on polystyrene slides

The current development in the medical engineering shows that polymers can be used as carrier materials for cell cultures. By means of certain surface modifications adhesive behavior and the direction of cell growth can be influenced systematically (Figure 1) [3, 4]. A combination of these cell guidance structures with a suitable integrated sensor technology opens absolutely new investigation possibilities in the cell culture technology.

Materials and methods

An important point is the selection of a suitable sensor structure. Essentially three different impedance sensor structures can be distinguished. The so-called electric cell substrate impedance sensors (ECIS) [5, 6], the interdigital electrode structures (IDES) [7, 8] and the array structures [9, 10]. These main types show fundamental differences in the operating mode, in the analytic

consideration of the circuitry situation and/or in the possibility of the interpretation of the results.

The concept of the ECIS describes an electrode arrangement which consists of a point-shaped operating electrode and a surrounding, ring-shaped reference electrode. The surface area of the reference electrode is substantially larger in comparison to the operating electrode. The distance between the reference and operating electrode is chosen larger than the dimensions of the operating electrode. In comparison to the dimension of the cells both electrodes have larger dimensions. The current flow occurs between the operation electrode and the reference electrode. In this case only the processes at the reference electrode are of significant influence on impedance. The current between the two electrodes crosses the complete cell layer. This allows investigations to the surfaces-related paracellular resistance of endothelial monolayers (the so-called tight junctions).

The IDES consists of meandrously arranged electrodes. The widths of the electrodes (operating and reference electrode) and electrode gaps are equal. The current flows in the area between the meandrous structures. This requires an isolation of the supply structures. The width of the electrodes and electrode gaps is comparable to the cell dimensions. Due to the smaller dimensions and the large cell-sensitive surface (operating and reference electrode are working sensitively) lower cell populations already change the impedance of the uncovered system. Furthermore this electrode arrangement allows better compensation of locally restricted changes. The effect of the culture medium is reduced. The resulting signal is steady therefore. The IDES is suited very well to control the adhesion of cells or for pharmaceutical attempts (e. g. influence of contaminants).

The sensor arrays consist of individually addressable electrode pads that represent the active electrodes, and large reference electrodes. The electrode pads have footprints in the range of $15 \mu\text{m}^2$ to $480 \mu\text{m}^2$, the reference electrodes are substantially larger. To cause clear changes in the measurable impedance of the system, the size of the electrode pads is chosen in such a way, that single cells can already cover them. The current flows from the actually addressed electrode pad to the reference electrodes. The array configuration allows the local resolution of the adhesion of cells by the examination of the resistances between the selected electrode pad and the reference electrodes. Vertical cell movements can also be detected.

For the performed impedance measurements in cell cultures on polymer slides an interdigital electrode structure was chosen. This represents a suitable tool to monitor the adherence and morphologic condition of cells. To be able to describe the effects appearing during the measuring theoretically a general equivalent circuit diagram was developed for the sensor arrangement (Figure 2).

- C_{dl} – double layer capacity
- R_{ct} – charge transition resistance
- Z_w – WARBURG-impedance
- R_{ICbas}, R_{ICap} – ion channel resistance basal, apical
- C_{Mbas}, C_{Map} – membrane capacity basal, apical
- R_{cyt} – cytoplasm resistance
- R_S – culture medium resistance
- R_b – tight junction resistance
- $R_{\alpha 1}$ – resistance under cells on sensor
- $R_{\alpha 2}$ – resistance under cells on slide

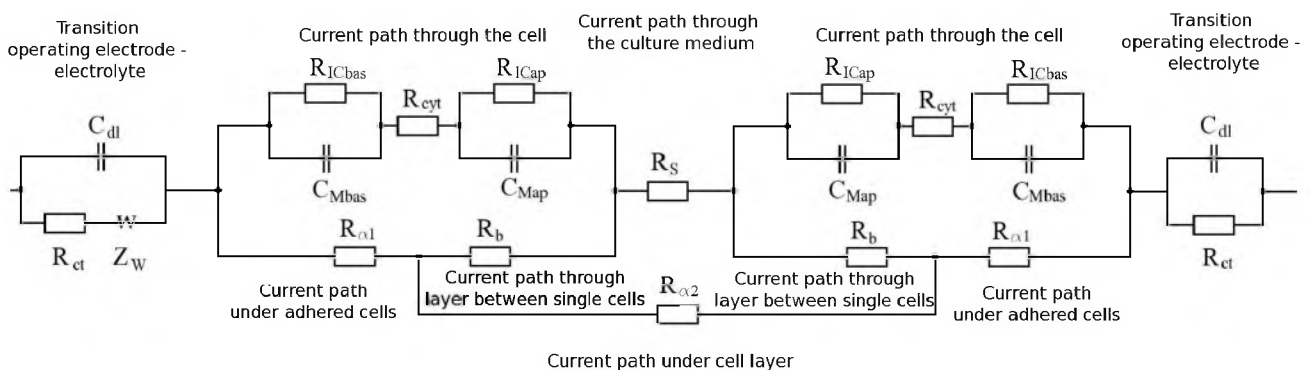

Figure 2: general equivalent circuit diagram of the measurement situation

This general equivalent circuit diagram can be simplified depending on the specific measuring situation. The three possible states are none, partial or full cell covering. With fully developed fibroblast monolayer the equivalent circuit diagram can be strongly simplified (Figure 3). The cytoplasm, ion channel and tight junction resistances can be neglected. The cell is regarded as a summarized membrane capacity C_M . The current flow under the cell layer between the sensors does not occur. The double layer capacity C_{dl} , the charge transition resistance R_{ct} and the WARBURG-impedance are summarized to a so-called "constant phase element" CPE which represents the electrode-electrolyte transition.

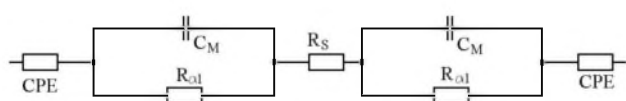

Figure 3: simplified equivalent circuit diagram – fibroblast monolayer

The sensor fabrication and the developed associated perfusion system are to be discussed in the following.

As electrode material for the impedance sensors platinum was chosen. The 50 nm thick electrode structures were raised by means of pulsed laser deposition (PLD). For this a 1064 nm Nd:YAG laser with 10 Hz repetition rate and 10^{-8} mbar working pressure was used. The required deposition masks (Figure 4) were made of 250 μm thick 4 inch silicon wafers. A scanner-coupled laser system AVIA-X with 355 nm wavelength, 100 μJ pulse energy, 50 kHz of repetition rate and 200 mm/s movement speed of the laser beam was used to cut the deposition masks. Both the width and the distances between the sensitive surfaces constitute 50 μm in each case.

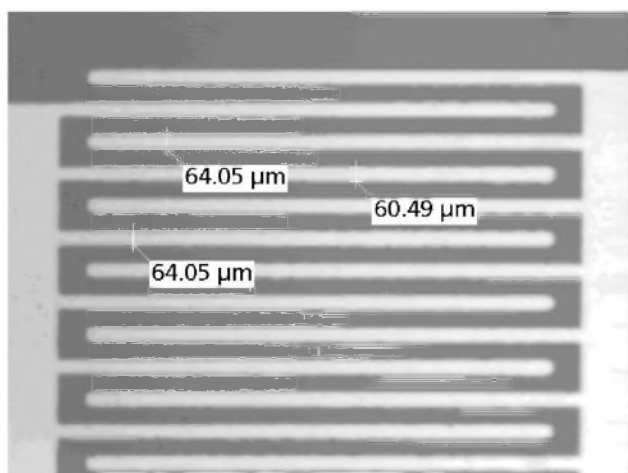

Figure 4: PLD deposition mask

The electrical feed lines were passivized with a silicon dioxide layer. For this a RF-sputter system at 13.56 MHz and 200 W was used.

Highly purified polymeric slides (26 mm x 76 mm according to DIN ISO 8037-1) made of polystyrene 143E (BASF) were used as substrates. These can be pretreated differently according to the corresponding demand. In a developed functionalizing chamber these slides can be selectively functionalized by means of high-energy excimer laser irradiation (ArF – 193 nm, KrF – 248 nm) under different reactive gas atmospheres (air, nitrogen, ammonia, argon). By means of the different reactive gases the formation of certain functional groups can be forced. Another advantage of the use of this polymer is the transparency and the given possibility of microscopic control of the cell culture.

The contacting of the platinum sensors takes place by means of commercial spring contacts (FIXTEST GmbH, Engen). These were integrated into the developed perfusion culture chamber (Figure 5).

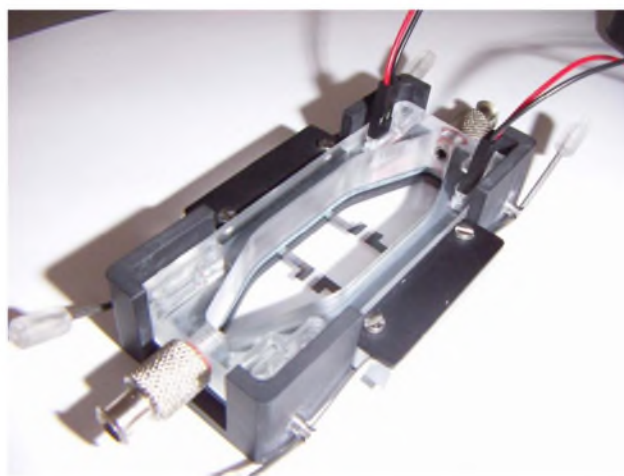

Figure 5: perfusion culture chamber with contacted sensors

The perfusion cell culture system was developed as a technology platform for cell micro array based sensors. The modular structure supports the application in different applications [11]. The system is designed for standardized slides but it also allows the application of slides with divergent thickness (0.8 mm - 2 mm) by the variable locking system. Thus a greatest possible compatibility to standardized evaluation procedures is guaranteed.

The chamber insert consists of commercial polycarbonate and is set in a housing of anodized aluminum on the cell culture slide (Figure 6).

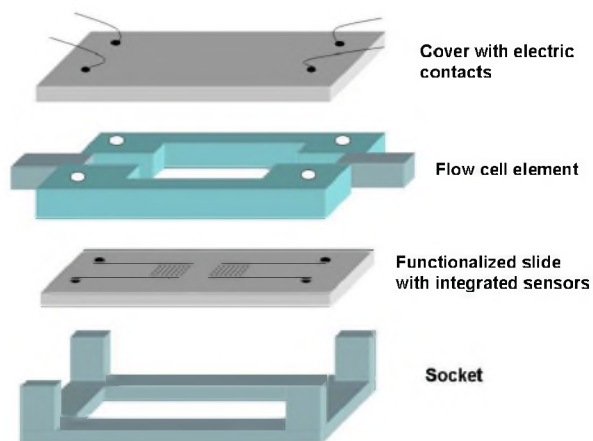

Figure 6: perfusion culture chamber (schematic exploded view)

Silicone (WS 6.088, KAUTASIT-Gummitechnik GmbH, Dresden) was used as sealing material. The perfusion chamber is connected to the supply system via a Luer-Lock connection according to DIN EN 1707. The supply system consists of a supply bottle with fresh culture medium, a waste container for used medium and a pump for the realization of the circulation (Figure 7).

The system can be admitted with different test substances over a dispenser (Figure 8). Therefore many medical and pharmaceutical investigations can be carried out.

The perfusion chamber was optimized according to the flow conditions to secure a uniform distribution of the additives in the chamber. The influence of microfluidic as well as macrofluidic aspects of the chamber geometry was taken into consideration. Simulations were carried out by computational fluid dynamics (CFD) simulation.



Figure 7: perfusion cell culture system in use

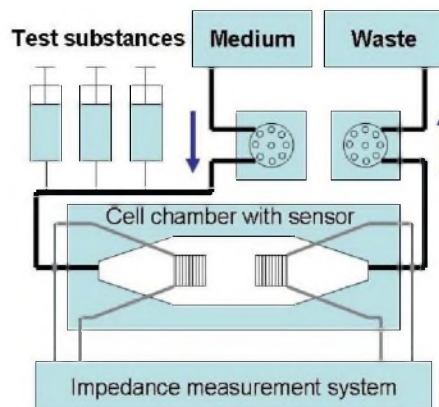

Figure 8: perfusion cell culture system (schematic)

The impedance analyzer HP4192A (Hewlett Packard Development Company, L.P.) was used to carry out the impedance spectroscopic measurements. It offers a wide measurement range (5 Hz - 13 MHz) and can be configured and read out by means of an IEEE 488 interface.

The sensors are connected in a four terminal pair configuration. Stray capacitances and remaining inductances are minimized by this method. As a suitable frequency range for the impedance measurement frequencies between 10 Hz and 100 kHz were chosen. In this range significant changes of the signal response are to be expected during the cell cultivation. When operating with electrode-electrolyte transitions it is generally advisable to work with small voltages. The behavior of the transition can be considered as linear for a signal less than 10 mV. To avoid any impairment of the cells, the flowing current must be limited. It can be assumed that a current I_{max} of maximally 1 μ A does not affect the cells. For the performed measurements a multiplier of 200 kOhm and an output voltage amplitude of 100 mV were chosen. Therefore the current is limited to 0.5 μ A.

For an easy and clear configuration of the impedance measurement a user interface was programmed in LABVIEW (National Instruments Corporation). Thus an automatic long-term monitoring and data acquisition at cell cultures is facilitated.

For the cell cultures fibroblast of the cell lines L929 and M2-10B4 are used. These are adhering cell lines, which form a cell monolayer. The cell culture tests are carried out for a period of 72 h by default. RPMI 1640 culture medium (Sigma-Aldrich Co.) is used for cell cultivation.

Results

At first comprehensive test rows were carried out to examine the sensor function. Media with different conductivities were tested. The functionality of the sensor has been proven.

Subsequently, cell culture tests over 24 h were accomplished. The seeding density was respectively 2.5×10^4 cells per cm^2 . After the seeding and after 24 h in culture an impedance-spectroscopic measurement was accomplished. For comparison purposes the cells vegetation was documented also visually.

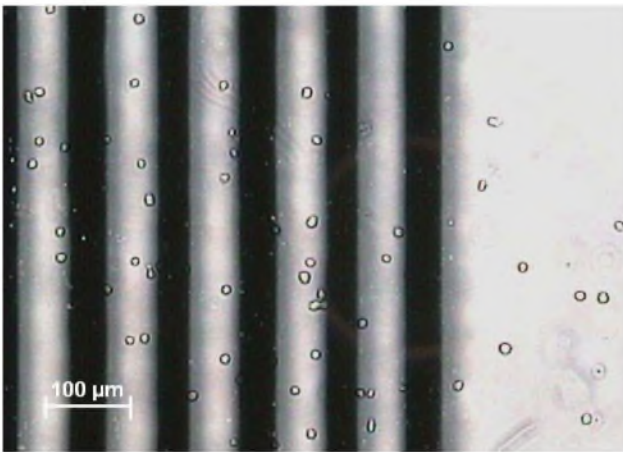

Figure 9: not adhered cells over sensor after seeding

The microscopic image shows not adhered cells, immediately after seeding (Figure 9). At this time, the impedance spectrum shows the same distribution, like with a pure culture medium (Figure 11).

After 24 h in cell culture a partially developed cell monolayer can be seen (Figure 10). An increase of the absolute value of the impedance is to be recognized in the impedance spectrum in a wide frequency range (100 Hz – 100 kHz) (Figure 11).

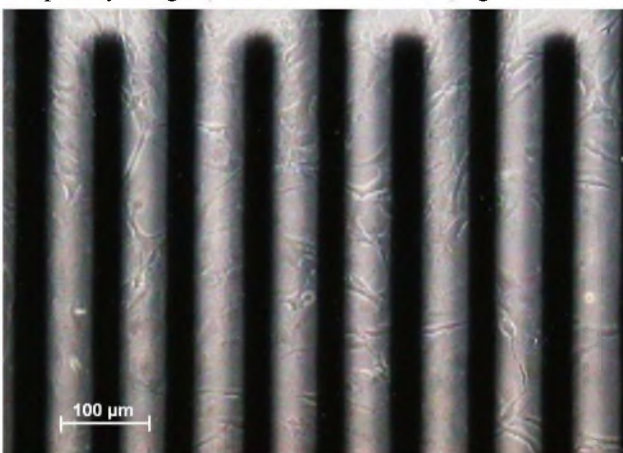

Figure 10: adhered cells on the impedance sensor

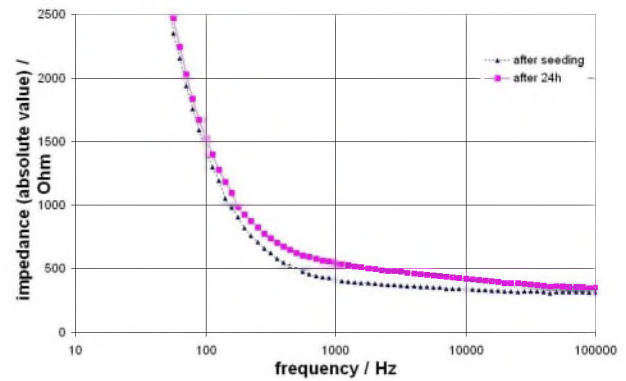

Figure 11: impedance spectrum

Discussion

The developed sensor system is suitable for the determination of the current condition of the cells within a cell culture. The simultaneous possibility of optical control under the microscope is a main advantage. An adhesion of the cells on the sensor can be detected clearly. It reflects in an increase of the absolute value of the impedance.

A significant measurement range can be postulated. The impedance spectrum after 24-hour incubation shows an significant distribution. The change of the impedance shows an increase greater 20 % in the area of 300 Hz - 25 kHz (Figure 12).

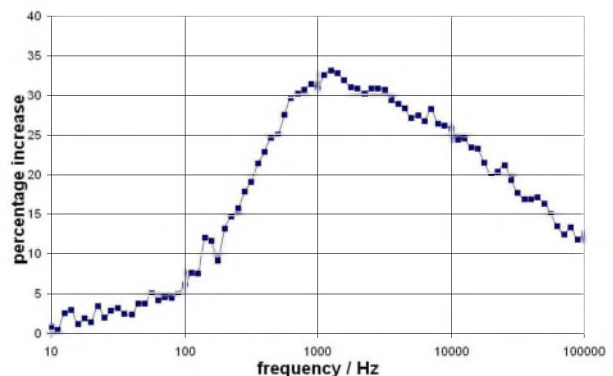

Figure 12: percentage increase of the impedance

Conclusions

The developed technology enables the fabrication and integration of biocompliant electrical cell based micro array sensors.

The adherence and direction of cell growth can be influenced by specific surface modification. So it is possible to line up cell collectives between two electrodes in a stripe-shaped way. With a suitable microfluidic supply the individual cell collectives can be supplied with different test substances or different concentrations of a test substance (Figure 13).

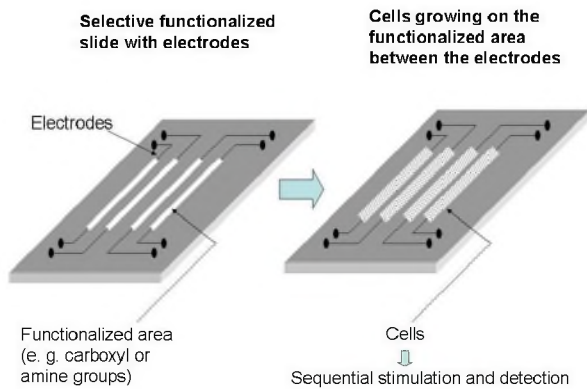

Figure 13: cell based micro array sensor

By the modular assembling, the combination of different cell culture carriers, sensors, functionalizing methods and microfluidic systems a variety of scientific and close-to-applications questions can be processed.

The feasibility of user-defined electrode geometries, functionalized structures and microfluidic systems allows the implementation of novel cell based sensors. Possible applications are the investigations of the impulse forwarding of neural cells or the cell toxicity tests at liver cells. By means of the chosen electrodes each cell collective can be stimulated and characterized individually. Thus, for example, the effect of new drugs can be examined for cells *ex vivo*.

The use of transparent polymers as substrate material allows a simultaneous verification of the measuring results with a customary microscope.

Acknowledgments

The authors would like to thank the federal ministry for economics and work (BMWA) and the AiF „Otto von Guericke“ for supporting this research project (FV-No.: 14394 BR/1).

References

1. Riu, J. *et al*, “Electrical Bioimpedance Methods: Applications to Medicine and Biotechnology” *The New York Academy of Sciences*, 1999.
2. Poll, R. *et al*, “Technologieplattform für Zell-Mikroarray basierte Sensoren”, *Gerlach, G. (publisher): Neue Herausforderungen und Anwendungen in der Sensortechnik*, Vol. 24, (2005), pp. 113-116.
3. Li, P. *et al*, “Laser Ablation Patterning by Interference Induces Directional Cell Growth”, *IEEE Transactions Nanobioscience 2*, Vol. 3, (2003), pp. 138-145.
4. Kunze, A. *et al*, “Technology of localized surface modification”, *Biomedizinische Technik*, Vol. 50, (2005), pp. 542-543.

5. Keese, C. R.; Giaever, I., “A Biosensor that Monitors Cell Morphology with Electrical Fields.”, *IEEE Engineering in Medicine and Biology*, (1994), pp. 402-408.
6. Seebach, H. J. *et al*, “Elektrische Impedanzspektroskopie - Eine neue Methode zur Untersuchung der endothelialen Barrierefunktion unter statischen und Schubspannungsbedingungen”, *Matschke, K. (publisher): 23. Jahrestagung der Deutschen Gesellschaft für Klinische Mikrozirkulation und Hämorheologie – Myokardiale Zirkulation*, (2004), pp. 79-100
7. Wolf, B., “Bioelektronische Sensor-Chips für biomedizinische Forschung, Diagnostik und pharmazeutisches Screening”, *health technologies*, Vol. 4, (2003), pp. 4-7.
8. Brischwein, E. R. *et al*, “Functional cellular assays with multiparametric silicon sensor chips”, *Lab on a chip*, Vol. 3, (2003), pp. 234-240.
9. Huang, D.W. *et al*, “Impedance-based Biosensors” www.ece.cmu.edu/~dwg/research/mrs2004.pdf, 2004, online-ressource
10. Borkholder D. A., “Functional cellular assays with multiparametric silicon sensor chips” *Masterthesis, Stanford University, Department of Electrical Engineering*, 1998
11. Jäger, M. *et al*, “Perfusion Chamber for Cell Tests with Micropatterned Surface”, *Biomedizinische Technik*, Vol. 50, (2005), pp. 211-212.