

Least Reflexive Points of Relations

Jules Desharnais * (jules.desharnais@ift.ulaval.ca)
Département d'Informatique, Université Laval, Québec, QC, G1K 7P4 Canada

Bernhard Möller
(bernhard.moeller@informatik.uni-augsburg.de)
Institut für Informatik, Universität Augsburg, D-86135 Augsburg, Germany

Abstract. Assume a partially ordered set (S, \leq) and a relation R on S . We consider various sets of conditions in order to determine whether they ensure the existence of a least reflexive point, that is, a least x such that xRx . This is a generalization of the problem of determining the least fixed point of a function and the conditions under which it exists. To motivate the investigation we first present a theorem by Cai and Paige giving conditions under which iterating R from the bottom element necessarily leads to a minimal reflexive point; the proof is by a concise relation-algebraic calculation. Then, we assume a complete lattice and exhibit sufficient conditions, depending on whether R is partial or not, for the existence of a least reflexive point. Further results concern the structure of the set of all reflexive points; among other results we give a sufficient condition that these form a complete lattice, thus generalizing Tarski's classical result to the nondeterministic case.

Keywords: Least reflexive point, greatest reflexive point, fixed point, lattice, partial order, relation, inflationary relation.

1. Introduction

Iterative and recursive processes are at the very center of computer science. The mathematical background is the theory of (least) fixed points and is well understood in the case where the iteration can be described by a (total) *function* [4, 8].

Much less is known about fixed points of *relations*. The problem *Find the least x related to itself* was stated to the first author in these terms by Robert Paige in 1992, at the 44th meeting of the IFIP Working Group 2.1 (*Algorithmic Languages and Calculi*), which was held in Augsburg, Germany, and was organized by the second author. This problem has its origin in the work presented in [3]. There, the authors are concerned with the construction of efficient algorithms expressed in a language using set-theoretic queries augmented with nondeterministic minimal and maximal fixed point queries (the deterministic case is treated in an earlier paper [2]).

* This research is supported by a grant from NSERC (Natural Sciences and Engineering Research Council of Canada).

Let us state the problem more precisely. Consider a partially ordered set (S, \leq) and a binary relation R on S . A *reflexive point of R* is an element $x \in S$ such that xRx . In the sequel we give conditions under which R has a least reflexive point; moreover, we investigate the structure of the set of all reflexive points of R . It turns out that under a suitable relational generalization of the property of monotonicity, the set of reflexive points even forms a complete lattice, so that Tarski's classical results generalize nicely to the nondeterministic case.

As a starting point, we present in Section 2 a theorem by Cai and Paige [3] giving conditions under which iterating R from the bottom element of the partial order necessarily leads to a minimal reflexive point; this theorem is based on the notion of an *inflationary relation*.

In Section 3, we first define four conditions generalizing monotonicity. Then, we examine which combinations of these, if any, are sufficient to ensure the existence of a least reflexive point; total and partial relations are tackled separately. In Section 4, we uncover some additional structure on the set of reflexive points. In Section 5, we use duality principles to present analogous results about greatest reflexive points. In Section 6, we study another set of four possible generalizations of monotonicity and we explain their relationship with the four conditions of Section 3.

We conclude with an evaluation of the results achieved and directions for future research. There are also two appendices. Appendix A gives graphical representations of the lattices and relations used as examples in the paper. They are grouped together to facilitate comparisons. The diagrams are labelled alphabetically. In the text, we refer to these diagrams by "Appendix A(a)", "Appendix A(b)", etc. Appendix B contains examples for all possible combinations of the conditions from Section 3 and all possible combinations of those of Section 6.

2. Reflexive points of inflationary relations

As mentioned in the introduction, Cai and Paige [3] are concerned with the construction of efficient algorithms expressed in a language using set-theoretic queries augmented with nondeterministic minimal and maximal fixed point queries. A typical algorithm is one that finds a maximal independent set of vertices of an undirected graph. A *maximal independent set* of an undirected graph (V, E) is a subset $U \subseteq V$ such that for any $(u, v) \in E$, at most one of u and v is in U and, for any $u \in V - U$, there is a vertex $v \in U$ such that $(u, v) \in E$.

Consider the following graph. It has two maximal independent sets of vertices, namely $\{1, 3\}$ and $\{2, 4\}$.

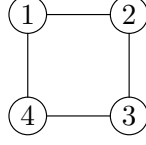

An algorithm incrementally building a maximal independent set would initially choose any vertex and add new vertices, provided that this preserves independence, until a fixed point is reached where no more vertices can be added. Here is such an algorithm:¹

```

U := ∅ ;
while ∃(v : v ∈ V - U : U ∪ {v} is independent) do
  U := U ∪ ∃{v | U ∪ {v} is independent}
  
```

The expression $\exists S$ denotes an arbitrary element from the nonempty set S . The following relation on the powerset $\mathcal{P}\{1, 2, 3, 4\}$ is the relation computed by the body of the nondeterministic loop, i.e., the set of pairs (U_1, U_2) such that U_2 is a possible value of variable U after one execution of the body of the loop if U_1 is the value of U before the execution.

$$R := \left\{ \begin{array}{lll} (\emptyset, \{1\}) & (\{1, 2\}, \{1, 2\}) & (\{1, 2, 3\}, \{1, 2, 3\}) \\ (\emptyset, \{2\}) & (\{1, 3\}, \{1, 3\}) & (\{1, 2, 4\}, \{1, 2, 4\}) \\ (\emptyset, \{3\}) & (\{1, 4\}, \{1, 4\}) & (\{1, 3, 4\}, \{1, 3, 4\}) \\ (\emptyset, \{4\}) & (\{2, 3\}, \{2, 3\}) & (\{2, 3, 4\}, \{2, 3, 4\}) \\ (\{1\}, \{1, 3\}) & (\{2, 4\}, \{2, 4\}) & (\{1, 2, 3, 4\}, \{1, 2, 3, 4\}) \\ (\{2\}, \{2, 4\}) & (\{3, 4\}, \{3, 4\}) & \\ (\{3\}, \{1, 3\}) & & \\ (\{4\}, \{2, 4\}) & & \end{array} \right\} \quad (1)$$

This relation has no least reflexive point, but it has many minimal ones, namely all the subsets of $\{1, 2, 3, 4\}$ with exactly two elements.

¹ Quantifiers have three arguments: a list of variables, the domain over which the quantification applies, and the quantified expression; for instance, $\forall(x : P : Q)$ is read “for all x satisfying P , Q holds”, or “for all x , $P \Rightarrow Q$ ”, while $\exists(x : P : Q)$ is read “there exists an x satisfying P and Q ”. When the second argument is true, it is omitted.

One interesting property of relation R in (1) is that any path starting at \emptyset necessarily leads to a minimal reflexive point. Hence, one can build a minimal reflexive point iteratively starting from \emptyset — this is what the above algorithm does. We now give sufficient conditions that ensure this property.

DEFINITION 1. *By V and I we denote the universal and identity relations, respectively. The complement of a set or relation R is denoted by \bar{R} . The composition (or relative product) of two relations Q and R is defined by*

$$Q;R := \{(s, u) \mid \exists(t :: sQt \text{ and } tRu)\}.$$

As usual, R^* denotes the reflexive and transitive closure of R . The converse of a relation R is defined by $R^\smile := \{(s, t) \mid tRs\}$.

Let (S, \leq, \perp) be a partial order with least element \perp . We say that a relation R on S is inflationary [3] iff R is total and included in \leq , i.e., $R;V = V$ and $R \subseteq \leq$. In elementwise terms this means $\forall(x :: \exists(y :: xRy))$ and $\forall(x :: \forall(y : xRy : x \leq y))$.

A relation R is progressively finite [7] iff there is no infinite chain s_0, s_1, s_2, \dots , with $(s_i, s_{i+1}) \in R$, for all $i \geq 0$.

Because the notion of *well-foundedness* is often used to characterize relations that do not have infinite chains, we remark that R is progressively finite iff its converse is well-founded.

PROPOSITION 2. *Let Q and R be relations and $f(X) := R;X \cup Q$.*

1. *If R is progressively finite, then f has a unique fixed point, viz. $R^*;Q$ [1].*
2. *If $Q \subseteq R$ and R is progressively finite, then Q is progressively finite.*

We now want to give a short proof of the result of [3] that, for an inflationary relation R on a progressively finite order, iteration from an arbitrary element necessarily leads to a reflexive point. To state this in relation-algebraic terms we first observe that $R \cap I$ is a partial identity relation characterizing the set of reflexive points of R . Hence we have $xR^*; (R \cap I)y$ iff from x we can reach a reflexive point y by iterating R . The claim follows if we can show that this relation is total, which is expressed by $R^*; (R \cap I); V = V$.

THEOREM 3. *Let (S, \leq) be a partial order such that $<$ is progressively finite. Let R be a relation on S . If R is inflationary, then*

$$R^*; (R \cap I); V = V.$$

Proof. Using that R is inflationary (hence total), simple Boolean laws and distributivity of “;” over \cup , we get

$$V = R;V = ((R \cap I) \cup (R \cap \bar{I});V = (R \cap I);V \cup (R \cap \bar{I});V.$$

This means that V is a fixed point of the function

$$f(X) := (R \cap I);V \cup (R \cap \bar{I});X.$$

But $R \cap \bar{I}$ is included in $<$, which is progressively finite by assumption. Hence, by Proposition 2, function f has a unique fixed point, which is $(R \cap \bar{I})^*; (R \cap I); V$. We conclude that

$$V = (R \cap \bar{I})^*; (R \cap I); V \subseteq R^*; (R \cap I); V.$$

□

If (S, \leq) has a least element \perp then \perp is a natural starting point for the iteration of R .

The relation R given in (1) is inflationary, using the ordering \subseteq on $\mathcal{P}\{1, 2, 3, 4\}$, and \subset is progressively finite. This is why from any subset of $\{1, 2, 3, 4\}$ there is a path by R to a reflexive subset of $\{1, 2, 3, 4\}$.

We now present a different example, where relation R still satisfies the preconditions of Theorem 3, and also has a least reflexive point. The lattice is $\mathcal{P}\{1, 2, 3\}$ with the inclusion ordering. The relation R is the Hasse diagram of \subset plus the pair $(\{1, 2, 3\}, \{1, 2, 3\})$, that is,

$$R := \left\{ \begin{array}{lll} (\emptyset, \{1\}) & (\{1\}, \{1, 2\}) & (\{1, 2\}, \{1, 2, 3\}) \\ (\emptyset, \{2\}) & (\{1\}, \{1, 3\}) & (\{1, 3\}, \{1, 2, 3\}) \\ (\emptyset, \{3\}) & (\{2\}, \{1, 2\}) & (\{2, 3\}, \{1, 2, 3\}) \\ & (\{2\}, \{2, 3\}) & (\{1, 2, 3\}, \{1, 2, 3\}) \\ & (\{3\}, \{1, 3\}) & \\ & (\{3\}, \{2, 3\}) & \end{array} \right\} \quad (2)$$

This relation could correspond to an (extremely simple) algorithm that, given a set T , adds to T an element not in T , if there is any. Note that R is inflationary and that \subset is progressively finite. Thus Theorem 3 applies and explains why from any subset of $\{1, 2, 3\}$ there is a path to the unique reflexive point $\{1, 2, 3\}$.

3. Four conditions generalizing monotonicity

In this section, we generalize the classical fixed point theory of monotonic functions on complete lattices to the relational case. Therefore, we assume the partial order to be a complete lattice $(S, \sqcap, \sqcup, \perp, \top, \leq)$. Letting R be a binary relation on S , we give in Theorem 5 a sufficient condition implying the existence of a least reflexive point for R when R is a total relation. A consequence of this lemma is Theorem 12 in Section 4, which shows that under the same condition the set of reflexive points of total relations is a complete lattice. We deal with partial relations in Section 3.4.

We use the following notation, where, for any $T \subseteq S$, $\sqcap T$ and $\sqcup T$ denote the meet and join, respectively, of the elements in T :

$$xR := \{y \mid xRy\} \quad (\text{the set of images of } x)$$

and

$$\begin{aligned} \text{(a)} \quad m_{\sqcap} &:= \sqcap \{x \mid \sqcap xR \leq x\}, \\ \text{(b)} \quad m_{\sqcup} &:= \sqcap \{x \mid \sqcup xR \leq x\}. \end{aligned} \tag{3}$$

The elements m_{\sqcap} and m_{\sqcup} generalize the notion of least prefixed point of a function; indeed, for a total function R , we have $\sqcap xR = \sqcup xR =$ the unique image of x , so that $m_{\sqcap} = m_{\sqcup} =$ the least prefixed point of R .

3.1. MONOTONICITY OF RELATIONS

In the theory of fixed points of functions, monotonic functions play a major role and we seek generalizations of this notion to the case of relations. The following are four natural conditions that can be imposed on R :

$$\begin{aligned} \text{(a)} \quad &\forall(x, y : x < y : \sqcap xR \leq \sqcap yR), \\ \text{(b)} \quad &\forall(x, y : x < y : \sqcap xR \leq \sqcup yR), \\ \text{(c)} \quad &\forall(x, y : x < y : \sqcup xR \leq \sqcap yR), \\ \text{(d)} \quad &\forall(x, y : x < y : \sqcup xR \leq \sqcup yR). \end{aligned} \tag{4}$$

These are natural conditions because they all constrain in some way how the ‘‘packet’’ of images of x increases with increasing x , by saying how the lower and upper bounds of these images increase. When R is a total function, all are equivalent and they all state that R is monotonic (due to $\sqcap xR = \sqcup xR =$ the unique image of x).

A total function is an extreme case of a relation. There are two more relaxed cases: that of total relations and that of partial functions (*functions* for short, in the sequel). If relation R is total, then $\sqcap xR \leq \sqcup xR$, for all x . If R is *functional* (i.e., is a partial function),

then $\sqcup xR \leq \sqcap xR$. This is why we obtain the following implications between Conditions 4(a,b,c,d).

$$\begin{array}{ccc}
 4(c) \Rightarrow 4(a) & & 4(c) \Leftarrow 4(a) \\
 \Downarrow & & \Uparrow \\
 4(d) \Rightarrow 4(b) & & 4(d) \Leftarrow 4(b)
 \end{array} \tag{5}$$

R total R function

From these diagrams, one can deduce that if R is a total function, all four Conditions 4(a,b,c,d) are equivalent, as mentioned above.

Although Conditions 4(a,b,c,d) are not independent for the special kinds of relations mentioned above, in the general case they are, as the following examples show.

1. Condition 4(a) does not follow from (the conjunction of) 4(b,c,d). Take S to be the lattice $\{\perp, \mathbf{a}, \mathbf{b}, \top\}$ with ordering $\perp < \mathbf{a} < \top$ and $\perp < \mathbf{b} < \top$, and

$$R := \{(a, a), (a, b), (b, a), (b, b), (\top, \top)\}. \tag{6}$$

See Appendix A(a).

2. Condition 4(b) does not follow from 4(a,c,d). This can be seen by taking the empty relation

$$R := \emptyset \tag{7}$$

on the lattice $\{\perp, \top\}$ with ordering $\perp < \top$. See Appendix A(b).

3. Condition 4(c) does not follow from 4(a,b,d). Take S to be the lattice $\{\perp, \mathbf{a}, \mathbf{b}, \top\}$ with ordering $\perp < \mathbf{a} < \top$ and $\perp < \mathbf{b} < \top$, and

$$R := \{(\perp, \mathbf{a}), (\perp, \mathbf{b}), (\mathbf{a}, \perp), (\mathbf{a}, \top), (\mathbf{b}, \perp), (\mathbf{b}, \top), (\top, \mathbf{a}), (\top, \mathbf{b})\}. \tag{8}$$

See Appendix A(c).

4. Condition 4(d) does not follow from 4(a,b,c). Take S to be the lattice $\{\perp, \top\}$ with ordering $\perp < \top$ and

$$R := \{(\perp, \perp), (\perp, \top)\}. \tag{9}$$

See Appendix A(d).

In fact, the independence is even more “complete”: there are examples for all 16 possible combinations of 4(a,b,c,d) (see Appendix B).

As is easily seen, 4(a) is equivalent to $x \leq y \Rightarrow \sqcap xR \leq \sqcap yR$, for all x and y ; this means that the function $(x :: \sqcap xR)$ is monotonic. Similarly, from 4(d), we get that $(x :: \sqcup xR)$ is monotonic. Because we assume a complete lattice, m_{\sqcap} and m_{\sqcup} are the least fixed points of $(x :: \sqcap xR)$ and $(x :: \sqcup xR)$, respectively:

$$\begin{aligned} \text{(a)} \quad & \text{Condition 4(a) implies } \sqcap m_{\sqcap}R = m_{\sqcap}, \\ \text{(b)} \quad & \text{Condition 4(d) implies } \sqcup m_{\sqcup}R = m_{\sqcup}. \end{aligned} \tag{10}$$

3.2. A STRONGER SET OF CONDITIONS

One may wonder why in 4(a,b,c,d) we did not use $x \leq y$ instead of $x < y$, which would give

$$\begin{aligned} \text{(a)} \quad & \forall(x, y : x < y : \sqcap xR \leq \sqcap yR), \\ \text{(b)} \quad & \forall(x, y : x < y : \sqcap xR \leq \sqcup yR), \\ \text{(c)} \quad & \forall(x, y : x < y : \sqcup xR \leq \sqcap yR), \\ \text{(d)} \quad & \forall(x, y : x < y : \sqcup xR \leq \sqcup yR). \end{aligned} \tag{11}$$

This is because of the following relationship between these properties:

$$\begin{aligned} 11\text{(a)} & \Leftrightarrow 4\text{(a)} \\ 11\text{(b)} & \Leftrightarrow 4\text{(b) and } R \text{ total} \quad (\text{if } \top \neq \perp) \\ 11\text{(c)} & \Leftrightarrow 4\text{(c) and } R \text{ functional} \\ 11\text{(d)} & \Leftrightarrow 4\text{(d)} \end{aligned} \tag{12}$$

The first and last equivalences are easy to see. The proof of the second one is based on the observation that if the set of images of x is empty, then

$$\sqcap xR \leq \sqcup xR \Leftrightarrow \top \leq \perp,$$

and the third equivalence is due to the fact that $\sqcup xR \leq \sqcap xR$ holds only if the set of images of x contains at most one element.

Since Conditions 11(b,c) are too strong, it is better to use 4(a,b,c,d) and add totality or functionality only as needed.

3.3. REFLEXIVE POINTS OF TOTAL RELATIONS

In this and the following subsection, we deal separately with total relations and partial relations, because this gives a clearer picture of the problem. We begin with the simpler case and assume in this section that relation R is total. Before showing the main result (Theorem 5), we need a lemma.

LEMMA 4. *Let R be a total relation satisfying Condition 4(c). Then*

$$m_{\sqcup}R = \{m_{\sqcup}\}.$$

In particular, m_{\sqcup} is a reflexive point of R .

Proof. Because R is total, $m_{\sqcup}R \neq \emptyset$. Thus, the result we have to prove is equivalent to $\forall(x : m_{\sqcup}Rx : x = m_{\sqcup})$, which we now show.

$$\begin{aligned}
& m_{\sqcup}Rx \\
\Rightarrow & \quad \langle \text{definition of join} \rangle \\
& m_{\sqcup}Rx \text{ and } x \leq \sqcup m_{\sqcup}R \\
\Rightarrow & \quad \langle 10(\text{b}), \text{ since } 4(\text{d}) \text{ holds by } (5) \rangle \\
& m_{\sqcup}Rx \text{ and } x \leq m_{\sqcup} \\
\Rightarrow & \quad \langle \text{splitting } x \leq m_{\sqcup} \text{ and weakening} \rangle \\
& x = m_{\sqcup} \text{ or } (m_{\sqcup}Rx \text{ and } x < m_{\sqcup}) \\
\Rightarrow & \quad \langle 4(\text{c}) \rangle \\
& x = m_{\sqcup} \text{ or } (m_{\sqcup}Rx \text{ and } \sqcup xR \leq \sqcap m_{\sqcup}R \text{ and } x < m_{\sqcup}) \\
\Rightarrow & \quad \langle m_{\sqcup}Rx \Rightarrow \sqcap m_{\sqcup}R \leq x \rangle \\
& x = m_{\sqcup} \text{ or } (\sqcup xR \leq x \text{ and } x < m_{\sqcup}) \\
\Rightarrow & \quad \langle 3(\text{b}) \rangle \\
& x = m_{\sqcup} \text{ or } (m_{\sqcup} \leq x \text{ and } x < m_{\sqcup}) \\
\Rightarrow & \quad \langle \leq \text{ is an ordering, and logic} \rangle \\
& x = m_{\sqcup} \quad \square
\end{aligned}$$

One may wonder whether m_{\sqcap} is also a reflexive point under the same conditions (totality + 4(c)). The following relation, on the lattice $\{\perp, \mathbf{a}, \mathbf{b}, \mathbf{c}, \top\}$ with ordering $\perp < \mathbf{a} < \mathbf{c} < \top$ and $\perp < \mathbf{b} < \mathbf{c} < \top$, shows that this is not the case (Appendix A(e)). For this relation, $m_{\sqcap} = \perp$.

$$R := \{(\perp, \mathbf{a}), (\perp, \mathbf{b}), (\mathbf{a}, \mathbf{c}), (\mathbf{b}, \mathbf{c}), (\mathbf{c}, \mathbf{c}), (\top, \top)\} \quad (13)$$

And here is the main result of this section.

THEOREM 5. *Let R be a total relation and assume Condition 4(c). Then R has a least reflexive point, viz.,*

$$l := \sqcap C, \quad \text{where } C := \{x \mid xRx\}.$$

Proof. Assume $l \notin C$. By the definition of meet then

$$\forall(x : x \in C : l < x). \quad (14)$$

We calculate:

$$\begin{aligned}
& (14) \\
\Rightarrow & \quad \langle 4(\text{c}) \rangle
\end{aligned}$$

$$\begin{aligned}
& \forall(x : x \in C : \sqcup lR \leq \sqcap xR) \\
\Rightarrow & \quad \langle x \in C \Rightarrow xRx \Rightarrow \sqcap xR \leq x \rangle \\
& \forall(x : x \in C : \sqcup lR \leq x) \\
\Rightarrow & \quad \langle \text{definition of meet} \rangle \\
& \sqcup lR \leq \sqcap C \\
\Rightarrow & \quad \langle \text{definition of } l \rangle \\
& \sqcup lR \leq l \\
\Rightarrow & \quad \langle 3(b) \rangle \\
& m_{\sqcup} \leq l.
\end{aligned}$$

By Lemma 4, $m_{\sqcup}Rm_{\sqcup}$, whence $m_{\sqcup} \in C$. Now instantiating $x := m_{\sqcup}$ in (14) gives $l < m_{\sqcup}$, a contradiction! \square

The relation given in (13) is an example of a total relation that satisfies the precondition of Theorem 5 (i.e., Condition 4(c)). For another, less trivial, example of a relation satisfying 4(c), see (19). Condition 4(c) is very strong, since it implies 4(a,b,c,d) (see (5)).

One can check that the relation (1) of Section 2 satisfies none of the Conditions 4(a,b,c,d) (for instance, note that $\{1\} \subseteq \{1,2\}$ while $\bigcap\{1\}R = \bigcup\{1\}R = \{1,3\}$ and $\bigcap\{1,2\}R = \bigcup\{1,2\}R = \{1,2\}$). Hence, it is not too surprising that there is no least reflexive point.

We conclude this subsection on the case of total relations with the remark that Condition 4(c) in Theorem 5 cannot be relaxed to a weaker combination of 4(a,b,d). In (8) we see an example of a total relation that satisfies all of 4(a,b,d) and that has no reflexive point. On the other hand, relation R in (2) satisfies Conditions 4(a,b,d) but does not satisfy 4(c), while it has a unique reflexive point and thus a least one. So Conditions 4(a,b,c,d) do not cover all possible situations. This illustrates the need for other conditions, such as those presented in Section 2.

3.4. REFLEXIVE POINTS OF PARTIAL RELATIONS

We suppose here that R is not total, i.e., there is an $s \in S$ such that $sR = \emptyset$. As we will see, this introduces a strong constraint, because $\sqcap sR = \sqcap \emptyset = \top$ and $\sqcup sR = \sqcup \emptyset = \perp$. We exclude the trivial case where the lattice S contains only one element, since in this case the only partial relation is \emptyset , and it has no reflexive point. So, assume $\perp \neq \top$.

We could show that the conjunction of Conditions 4(a,b,c,d) is sufficient to ensure the existence of a least reflexive point. However,

this is a bit too strong. We start by exhibiting combinations of Conditions 4(a,b,c,d) that do not ensure the existence of a least reflexive point. This will help pinpointing the essential conditions.

- The relation R in (6) has three reflexive points, but no least one. This relation satisfies 4(b,c,d), but not 4(a). This shows that 4(a) is essential.
- The relation R in (7) has no reflexive point, hence no least one. This relation satisfies 4(a,c,d), but not 4(b). This shows that 4(b) is essential.

Thus, 4(a,b) are essential. However, they are not sufficient. The relation

$$R := \{(\perp, a), (\perp, b), (a, a), (a, b), (b, a), (b, b)\} \quad (15)$$

on the lattice $\{\perp, a, b, \top\}$, with ordering $\perp < a < \top$ and $\perp < b < \top$, satisfies 4(a,b) (it does not satisfy 4(c,d)) and has no least reflexive point. See Appendix A(f).

We will show, in this order, that each of the combinations 4(a,b,c) and 4(a,b,d) is sufficient. Before dealing with the first one, we derive a consequence of Conditions 4(a,b).

LEMMA 6. *Let R be a relation satisfying 4(a,b) and let s be such that $sR = \emptyset$. Then*

$$\forall(y : s < y : yR = \{\top\}).$$

Proof. By 4(a,b) and using $\sqcap sR = \sqcap \emptyset = \top$, we have

$$\forall(y : s < y : \top \leq \sqcap yR) \quad \text{and} \quad \forall(y : s < y : \top \leq \sqcup yR),$$

from which the result directly follows. \square

Note that Condition 4(b) implies that any two elements that are not in the domain of R are not related by \leq .

PROPOSITION 7. *Let R be a partial relation satisfying 4(a,b,c). Then R has a least reflexive point.*

Proof. The proof proceeds by case analysis.

1. Case 1: $\top R = \emptyset$. By Lemma 6, for all $x < \top$, $xR \neq \emptyset$. By 4(b), $\sqcap xR \leq \sqcup \top R = \sqcup \emptyset = \perp$.

- a) Case 1.1: the lattice is $\{\perp, \top\}$. There are only two relations that satisfy the above constraints, namely $\{(\perp, \perp), (\perp, \top)\}$ and $\{(\perp, \perp)\}$. For both of them, there is a single reflexive point, \perp .

- b) Case 1.2: the lattice is not $\{\perp, \top\}$. This implies that there is an element t such that $\perp < t < \top$, so that, by 4(c,b),

$$\sqcup \perp R \leq \sqcap t R \leq \sqcup \top R = \sqcup \emptyset = \perp.$$

Since $\perp R \neq \emptyset$, we have $\perp R = \{\perp\}$. Hence, \perp is a reflexive point and is obviously the least such.

2. Case 2: $\top R \neq \emptyset$. Consider the relation R' defined as follows:

$$\begin{aligned} xR' &:= xR && \text{if } xR \neq \emptyset, \\ xR' &:= \{\top\} && \text{if } xR = \emptyset \text{ (note: } x \neq \top). \end{aligned}$$

Relation R' is total and has the same reflexive points as R . We now show that R' satisfies Condition 4(c), so that it has a least reflexive point, by Theorem 5. By hypothesis, R satisfies 4(c), i.e.,

$$\forall(x, y : x < y : \sqcup xR \leq \sqcap yR).$$

Assume $x < y$. There are three cases to consider:

- a) $xR \neq \emptyset$ and $yR \neq \emptyset$: then $\sqcup xR' = \sqcup xR \leq \sqcap yR = \sqcap yR'$;
- b) $xR = \emptyset$ and $yR \neq \emptyset$: then $\sqcup xR' = \top = \sqcap yR = \sqcap yR'$, where Lemma 6 has been used;
- c) $yR = \emptyset$: then $\sqcup xR' \leq \top = \sqcap yR'$. □

In (9), we have already given an example of a partial relation that satisfies 4(a,b,c) but not 4(d). Another example is the lattice

$$\{\perp, a, b, c, d, e, f, g, \top\},$$

with ordering

$$\perp < a < \top, \perp < b < d < e < g < \top \text{ and } \perp < c < d < f < g,$$

and relation

$$\{(\perp, b), (\perp, c), (b, d), (c, d), (d, d), (e, e), (f, f), (g, g), (\top, \top)\}. \quad (16)$$

See Appendix A(g). Note that the least reflexive point is d , which means that the constraints 4(a,b,c) may lead to a somewhat more interesting situation than the next case that we analyze, where the least reflexive point is always one of \perp or \top .

Now we tackle the combination 4(a,b,d) and state a lemma similar to Lemma 6:

LEMMA 8. *Let R be a relation satisfying 4(b,d) and let s be such that $sR = \emptyset$. Then*

$$\forall(x : x < s : xR = \{\perp\}).$$

Proof. By 4(b,d) and using $\sqcup sR = \sqcup \emptyset = \perp$, we have

$$\forall(x : x < s : \sqcap xR \leq \perp) \quad \text{and} \quad \forall(x : x < s : \sqcup xR \leq \perp),$$

from which the claim directly follows. \square

Now we obtain

PROPOSITION 9. *Let R be a partial relation satisfying 4(a,b,d). Then R has a least reflexive point, which is either \perp or \top .*

Proof. Let s be such that $sR = \emptyset$. On the basis of Lemma 6 and Lemma 8, we distinguish three cases according to the value of s .

1. $s = \perp$: then $\perp R = \emptyset$ and $tR = \{\top\}$ for every $t \neq \perp$. There is a unique reflexive point, namely \top , which is thus the least and greatest reflexive point.
2. $s = \top$: then $\top R = \emptyset$ and $tR = \{\perp\}$ for every $t \neq \top$. There is a unique reflexive point, namely \perp , which is thus the least and greatest reflexive point.
3. $s \neq \perp$ and $s \neq \top$: then $\perp R = \{\perp\}$ and $\top R = \{\top\}$. There is thus a least reflexive point, \perp , and a greatest reflexive one, \top . \square

In case 3 of the previous proposition, there might be other reflexive points. As an example, take S to be the lattice $\{\perp, \mathbf{a}, \mathbf{b}, \top\}$ with ordering $\perp < \mathbf{a} < \top$ and $\perp < \mathbf{b} < \top$, and the partial function

$$R := \{(\perp, \perp), (\mathbf{b}, \mathbf{b}), (\top, \top)\}. \quad (17)$$

Here, $s = \mathbf{a}$. See Appendix A(h).

And now an example of a partial relation that satisfies 4(a,b,d) but does not satisfy 4(c): the lattice is $\{\perp, \mathbf{a}, \mathbf{b}, \mathbf{c}, \mathbf{d}, \mathbf{e}, \top\}$, with ordering $\perp < \mathbf{a} < \top$, $\perp < \mathbf{b} < \mathbf{c} < \mathbf{e} < \top$ and $\mathbf{b} < \mathbf{d} < \mathbf{e}$, and the relation is

$$\{(\perp, \perp), (\mathbf{b}, \mathbf{c}), (\mathbf{b}, \mathbf{d}), (\mathbf{c}, \mathbf{b}), (\mathbf{c}, \mathbf{e}), (\mathbf{d}, \mathbf{b}), (\mathbf{d}, \mathbf{e}), (\mathbf{e}, \mathbf{c}), (\mathbf{e}, \mathbf{d}), (\top, \top)\}. \quad (18)$$

See Appendix A(i). Note that the subrelation on elements $\{\mathbf{b}, \mathbf{c}, \mathbf{d}, \mathbf{e}\}$ is the same (modulo renaming) as the one in (8), which was used as a total relation illustrating that 4(a,b,d) does not imply 4(c).

4. Insights on the structure of the set of reflexive points

4.1. THE ROLES OF m_{\sqcap} AND m_{\sqcup}

The next proposition shows that every reflexive point is above m_{\sqcap} .

PROPOSITION 10. $\forall(x : xRx : m_{\sqcap} \leq x)$.

Proof. Using 3(a), we have $xRx \Rightarrow \sqcap xR \leq x \Rightarrow m_{\sqcap} \leq x$. \square

Based on the previous proposition, the next proposition shows that the reflexive points between m_{\sqcap} and m_{\sqcup} are linearly ordered; this only requires Condition 4(c). The relation R need not be total.

PROPOSITION 11. *Assume Condition 4(c). Then*

$\forall(x : xRx \text{ and } yRy : x \leq y \text{ or } y \leq x \text{ or } (m_{\sqcup} \leq x \text{ and } m_{\sqcup} \leq y))$.

Proof. Assume xRx and yRy .

true

$\Rightarrow x \sqcap y \leq x$ and $x \sqcap y \leq y$

$\Rightarrow (x \sqcap y = x \text{ or } x \sqcap y < x)$ and $(x \sqcap y = y \text{ or } x \sqcap y < y)$

$\Rightarrow x \sqcap y = x \text{ or } x \sqcap y = y \text{ or } (x \sqcap y < x \text{ and } x \sqcap y < y)$

$\Rightarrow \langle 4(c) \rangle$

$x \sqcap y = x \text{ or } x \sqcap y = y \text{ or}$

$(\sqcup (x \sqcap y)R \leq \sqcap xR \text{ and } \sqcup (x \sqcap y)R \leq \sqcap yR)$

$\Rightarrow \langle (xRx \Rightarrow \sqcap xR \leq x) \text{ and } (yRy \Rightarrow \sqcap yR \leq y) \rangle$

$x \sqcap y = x \text{ or } x \sqcap y = y \text{ or}$

$(\sqcup (x \sqcap y)R \leq x \text{ and } \sqcup (x \sqcap y)R \leq y)$

$\Rightarrow x \sqcap y = x \text{ or } x \sqcap y = y \text{ or } \sqcup (x \sqcap y)R \leq x \sqcap y$

$\Rightarrow \langle 3(b) \rangle$

$x \sqcap y = x \text{ or } x \sqcap y = y \text{ or } m_{\sqcup} \leq x \sqcap y$ \square

There can be an infinite number of reflexive points between m_{\sqcap} and m_{\sqcup} . Let S be the lattice $\mathbf{N} \cup \{\infty\}$, with the usual ordering, where \mathbf{N} is the set of natural numbers. Take

$$R := \{(m, n) \mid m = n \text{ or } (m \in \mathbf{N} \text{ and } n = m + 1)\}. \quad (19)$$

One can check that R satisfies 4(c), $m_{\sqcap} = 0$, $m_{\sqcup} = \infty$, and that every element of S is related to itself, and thus 0 is the least reflexive point. See Appendix A(j).

One may also have $m_{\sqcap} = m_{\sqcup}$. This is the case, for instance, of the relation in (16), see Appendix A(g). Note that for this relation, all the reflexive points are above m_{\sqcup} ($= m_{\sqcap} = \perp$) and that they are not linearly ordered.

It is even possible to have $m_{\sqcup} < m_{\sqcap}$. Consider for instance the relation $\{(\top, \top)\}$ on the lattice $\{\perp, \top\}$, for which $m_{\sqcap} = \top$ and $m_{\sqcup} = \perp$.

However, for total R we have

$$\{x \mid \sqcup xR \leq x\} \subseteq \{x \mid \sqcap xR \leq x\}$$

and hence $m_{\sqcap} \leq m_{\sqcup}$.

4.2. LATTICE STRUCTURE OF THE REFLEXIVE POINTS

We now come to main result of this section, viz. the generalization of Tarski's result [8] on the fixed points of a monotonic *total function* to the relational case.

THEOREM 12. *Let R be a total relation and assume Condition 4(c). Then the set of reflexive points of R is a complete lattice.*

Proof. The proof is adapted from [8]. We use interval notation:

$$[x, y] := \{z \mid x \leq z \leq y\}.$$

Moreover we extend the image notation to sets:

$$XR := \bigcup_{x \in X} xR.$$

Let $C := \{x \mid xRx\}$, assume $Y \subseteq C$ and set $y := \sqcup Y$. If $y \in Y$, then y is also the join of Y in C . Otherwise, we shall show that $Z := [y, \top]$ is closed under R . Then, since (Z, \leq) is a complete sublattice of (S, \leq) , the relation $R' := R \cap Z \times Z$ is a total relation on Z that satisfies 4(c). By Theorem 5, R' has a least reflexive element which therefore is the join of Y in C .

Indeed, if $y \notin Y$,

$$\begin{aligned} & \text{true} \\ \Rightarrow & \quad \langle y = \sqcup Y \text{ and } y \notin Y \rangle \\ & \quad \forall(u : u \in Y : u < y) \\ \Rightarrow & \quad \langle 4(c) \rangle \\ & \quad \forall(u : u \in Y : \sqcup uR \leq \sqcap yR) \\ \Rightarrow & \quad \langle \text{definition of join} \rangle \\ & \quad \sqcup \{\sqcup uR \mid u \in Y\} \leq \sqcap yR \end{aligned}$$

$$\begin{aligned}
&\Rightarrow \quad \langle \text{property of join} \rangle \\
&\quad \sqcup \bigcup \{uR \mid u \in Y\} \leq \sqcap yR \\
&\Rightarrow \quad \langle \text{definition of image} \rangle \\
&\quad \sqcup YR \leq \sqcap yR \\
&\Rightarrow \quad \langle \text{because } Y \subseteq C, \text{ so that } Y \subseteq YR \text{ and hence} \\
&\quad \quad \quad y = \sqcup Y \leq \sqcup YR \rangle \\
&\quad y \leq \sqcap yR \\
&\Rightarrow \quad \langle \text{by upward closure of } Z = [y, \top] \rangle \\
&\quad yR \subseteq Z. \tag{20}
\end{aligned}$$

We want to show $ZR \subseteq Z$. So consider $z \in Z$. If $z = y$ then $zR \subseteq Z$ was just shown. Otherwise

$$\begin{aligned}
&y < z \\
&\Rightarrow \quad \langle 4(c) \rangle \\
&\quad \sqcup yR \leq \sqcap zR \leq \top \\
&\Rightarrow \quad \langle \text{because } R \text{ is total, (20) implies } \sqcup yR \in Z; \\
&\quad \quad \quad \text{also by definition of intervals} \rangle \\
&\quad \sqcap zR \in Z \\
&\Rightarrow \quad \langle \text{upward closure of } Z \rangle \\
&\quad zR \subseteq Z.
\end{aligned}$$

This completes the proof. \square

Moreover, we have

PROPOSITION 13. *Let R be a total relation that satisfies Condition 4(c) and define $l := \sqcap \{x \mid xRx\}$. Then $m_{\sqcap} \leq l \leq m_{\sqcup}$.*

Proof. Lemma 4 shows that $m_{\sqcup}Rm_{\sqcup}$, hence $l \leq m_{\sqcup}$; using proposition 10 we get the result. \square

Finally, combining our results for the partial case with Theorem 12, we obtain

PROPOSITION 14. *Let R be a partial relation that satisfies 4(a,b,c) and $\top R \neq \emptyset$. Then the set of reflexive points is a complete lattice.*

Proof. In Case 2 of the proof of Proposition 7, it was shown that under the assumptions the set of reflexive points of R coincides with that of a total relation R' that satisfies condition (4(c)); hence it is a complete lattice by Theorem 12. \square

The condition $\top R \neq \emptyset$ is mandatory: the dual of Appendix A(a) satisfies 4(a,b,c) but has no greatest reflexive point, so that the set of reflexive points is not a complete lattice.

Unfortunately, the combination 4(a,b,d) does not guarantee a complete lattice of reflexive points, not even when $\top R \neq \emptyset$. This is shown in the example of Appendix A(n): the lattice is $\{\perp, a, b, c, d, e, f, g, h, i, \top\}$, with ordering $\perp < a < \top$, $\perp < b < c < e < f < g < i < \top$ and $b < d < e < f < h < i$, and the relation is

$$\begin{aligned} & \{(\perp, \perp), (b, c), (b, d), (c, c), (c, d), (d, c), (d, d), (e, c), (e, d), \\ & (f, g), (f, h), (g, g), (g, h), (h, g), (h, h), (i, g), (i, h), (\top, \top)\}. \end{aligned} \quad (21)$$

The set $\{\perp, c, d, g, h, \top\}$ of reflexive points is not a lattice, since, e.g., the subset $\{c, d\}$ has two minimal upper bounds, namely g and h . Note how the total relation of Appendix A(l), which also satisfies 4(a,b,d), is used twice as a sublattice of the partial relation of Appendix A(n).

5. Greatest reflexive points

We can obtain results for greatest reflexive points using properties of the least reflexive points in the dual of the given lattice. It suffices to replace \leq, \sqcap, \sqcup and “least” by \geq, \sqcup, \sqcap and “greatest”, respectively. Doing so reveals that Conditions 4(a), 4(b), 4(c) and 4(d) are dual to 4(d), 4(b), 4(c) and 4(a), respectively. Properties of total or partial relations then easily follow from the previous text.

By Proposition 7, the set of Properties 4(a,b,c) guarantees the existence of a least reflexive point. Its dual, 4(b,c,d), guarantees the existence of a greatest reflexive point. The question arises whether it is possible to have a relation satisfying 4(b,c,d), and thus having a greatest reflexive point, that does not have a least reflexive point. The answer is yes and is illustrated by the relation given in (6) and Appendix A(a).

6. Can monotonicity be characterized another way?

Since we are working in a relational setting, an obvious question is whether monotonicity can be characterized in a purely algebraic, point-free style.

6.1. CANDIDATE CONDITIONS AND THEIR INTERRELATION

For the case of total functions it is well known how to do this; when R is a total function, the following four conditions 22(a',b',c',d') all are equivalent to the usual pointwise definition of monotonicity. But for the same reasons as in discussed in Section 3.2, we will work with Conditions 22(a,b,c,d) (see also Section 6.2):

$$\begin{array}{ll}
\text{(a)} & <;R \subseteq R;\leq, & \text{(a')} & \leq;R \subseteq R;\leq, \\
\text{(b)} & < \subseteq R;\leq;R^\smile, & \text{(b')} & \leq \subseteq R;\leq;R^\smile, \\
\text{(c)} & R^\smile;<;R \subseteq \leq, & \text{(c')} & R^\smile;\leq;R \subseteq \leq, \\
\text{(d)} & R^\smile;< \subseteq \leq;R^\smile, & \text{(d')} & R^\smile;\leq \subseteq \leq;R^\smile.
\end{array} \tag{22}$$

However, in the case of general relations they are *not* equivalent. There, Condition 22(b') is equivalent to

$$\forall(x, y : x \leq y : \exists(u, v :: xRu \text{ and } yRv \text{ and } u \leq v));$$

this property could be called *existential monotonicity*. Similarly, 22(c') is equivalent to

$$\forall(x, y : x \leq y : \forall(u, v :: xRu \text{ and } yRv \Rightarrow u \leq v));$$

this property could be called *universal monotonicity*.

A first consequence of these properties is stated in

PROPOSITION 15. $22(a,d) \Rightarrow R = \emptyset$ or R total.

Proof. In this proof we will also need inverse images. The notation for them is dual to that for images:

$$Px := \{y \mid yPx\}, \quad PX := \bigcup_{x \in X} Px.$$

Note that PS is the domain of P , and hence P is total iff $PS = S$.

The following properties of the image operations are used, besides their monotonicity:

$$\begin{array}{ll}
X(P;Q) = (XP)Q, & \emptyset P = \emptyset, \\
(P;Q)X = P(QX), & P\emptyset = \emptyset.
\end{array} \tag{23}$$

Assume now 22(a,d). We consider two cases: $\top R = \emptyset$ and $\top R \neq \emptyset$.

1. Case $\top R = \emptyset$. Note that by the laws for converse, Condition 22(d) is equivalent to

$$>;R \subseteq R;\geq. \tag{24}$$

Consider now an arbitrary $x \neq \top$, i.e., $x \in \top>$. Then

$$xR \subseteq (\top>)R = \top(>;R) \subseteq \top(R;\geq) = (\top R)\geq = \emptyset \geq = \emptyset,$$

where besides monotonicity and (24) only (23) has been used. Since now for all $y \in S$ we have $yR = \emptyset$, it follows that $R = \emptyset$.

2. Case $\top R \neq \emptyset$, which is equivalent to $\top \in RS$. Then

$$RS \supseteq R(\leq S) = (R;\leq)S \supseteq (<;R)S = <(RS) \supseteq <\top,$$

where besides monotonicity and 22(a) only (23) has been used. Hence, every $x < \top$ is in the domain of R . Since \top is also in the domain of R by hypothesis, R is total. \square

6.2. INTERDEPENDENCE OF THE CONDITIONS

As in the case of our earlier Conditions 4, we state the connections between the unprimed and primed versions (see [5] for full proofs):

$$\begin{aligned} 22(a') &\Leftrightarrow 22(a) \\ 22(b') &\Leftrightarrow 22(b) \text{ and } R \text{ total} \\ 22(c') &\Leftrightarrow 22(c) \text{ and } R \text{ functional} \\ 22(d') &\Leftrightarrow 22(d) \end{aligned} \tag{25}$$

Hence, the situation is almost identical to that with Conditions 4 (see (12)), except for the equivalence of 22(b') and 22(b). Rather than using all eight Conditions 22, we will simply use Conditions 22(a,b,c,d) together with totality or functionality, like we did for Conditions 4.

One can show (see [5]) that the same implications hold between Conditions 22(a,b,c,d) as between 4(a,b,c,d) (see Equation (5)):

$$\begin{array}{ccc} 22(c) \Rightarrow 22(a) & & 22(c) \Leftarrow 22(a) \\ \downarrow & & \uparrow \\ 22(d) \Rightarrow 22(b) & & 22(d) \Leftarrow 22(b) \end{array} \tag{26}$$

$R \text{ total} \qquad R \text{ function}$

Here too, one can deduce from these diagrams that if R is a total function, all four Conditions 22(a,b,c,d) are equivalent, as was mentioned in the introductory part of Section 6.1.

In view of these striking similarities, one might expect that corresponding properties in 4(a,b,c,d) and 22(a,b,c,d) are equivalent. However, this is not the case, as the following theorem shows.

THEOREM 16. *The following relationships hold between Conditions 4 and 22. All implications are strict (i.e., equivalence does not hold).*

$$\begin{aligned}
22(a) &\Rightarrow 4(a) \\
22(b) &\Rightarrow 4(b) \\
22(c) &\Leftrightarrow 4(c) \\
22(d) &\Rightarrow 4(d)
\end{aligned}$$

Proof. For the proof of the implications see Appendix C. A single example (see Appendix A(k)) can be used to show that the three implications are strict: Take S to be the lattice $\{\perp, a, b, c, d, \top\}$ with ordering $\perp < a < c < \top$ and $\perp < b < d < \top$, and

$$\begin{aligned}
R := \{ &(\perp, c), (\perp, d), (a, c), (a, d), (b, c), (b, d), \\
&(c, a), (c, b), (d, a), (c, b), (\top, a), (\top, b) \}. \quad (27)
\end{aligned}$$

This total relation satisfies all of $4(a,b,d)$ and none of $22(a,b,d)$.

The partial relation given in (18) is another example showing the strictness of the implications. \square

In view of this situation, the question whether these conditions are independent cannot be reduced to our independence results in Section 3. A separate investigation shows the following:

1. Condition 22(b) does not follow from 22(a,c,d). This is shown by the relation given in (7) (Appendix A(b)).
2. Condition 22(c) does not follow from 22(a,b,d). This is shown by the lattice $\{\perp, a, \top\}$ with ordering $\perp < a < \top$ and the relation (see Appendix A(m))

$$R := \{(\perp, a), (\perp, \top), (a, a), (a, \top), (\top, \top)\}. \quad (28)$$

3. Conditions 22(a,d) both follow from 22(b,c).

Proof. We only show that $22(b,c) \Rightarrow 22(a)$, the proof of $22(b,c) \Rightarrow 22(d)$ being dual. In the proof, we replace $<$ by Q' and \leq by Q , for reasons of readability and to make it more obvious that no property particular to orderings is used.

$$\begin{aligned}
&Q' \subseteq R;Q;R^\smile \text{ and } R^\smile;Q';R \subseteq Q \\
\Rightarrow &\langle Q;R^\smile \subseteq V \text{ and monotonicity } \rangle \\
&Q' \subseteq R;V \text{ and } R;R^\smile;Q';R \subseteq R;Q \\
\Rightarrow &\langle I \cap R;R^\smile \subseteq R;R^\smile \text{ and monotonicity } \rangle \\
&Q' \subseteq R;V \text{ and } (I \cap R;R^\smile);Q';R \subseteq R;Q \\
\Leftrightarrow &\langle I \cap R;R^\smile = I \cap R;V \rangle
\end{aligned}$$

$$\begin{aligned}
& Q' \subseteq R;V \text{ and } (I \cap R;V);Q';R \subseteq R;Q \\
\Leftrightarrow & \quad \langle \text{for all } P, Q, R, (P \cap R;V);Q = P;Q \cap R;V \rangle \\
& Q' \subseteq R;V \text{ and } Q';R \cap R;V \subseteq R;Q \\
\Rightarrow & \quad \langle Q' \subseteq R;V \Rightarrow Q';R \subseteq R;V \rangle \\
& Q';R \subseteq R;Q \quad \square
\end{aligned}$$

4. Conditions 22(a,d) imply 22(b) or 22(c).

Proof. Note that $R = \emptyset$ implies 22(c). Also, by (26), R total and 22(a) imply 22(b). The result then follows from Proposition 15. \square

Thus the independence properties of Conditions 22 are different from those of Conditions 4 and one cannot have combinations like 22(a,b,c) and 22(b,c,d) without having all of 22(a,b,c,d). However, all the remaining combinations of our properties can be exemplified with lattices and relations, see Appendix B.

6.3. ON THE EXISTENCE OF LEAST REFLEXIVE ELEMENTS

Do the algebraic Conditions 22 ensure the existence of least reflexive elements of *partial* relations in the same manner as Conditions 4? Unfortunately, this is *not* the case, as can be seen as follows. The example in (7) (Appendix A(b)) satisfies 22(a,c,d), but has no reflexive point, so that 22(b) is essential for the existence. On the other hand, 22(b) implies totality of R , as the following derivation shows:

$$\begin{aligned}
& 22(b) \\
\Leftrightarrow & \quad \langle \text{by definition} \rangle \\
& < \subseteq R; \leq; R^\sim \\
\Rightarrow & \quad \langle \text{monotonicity} \rangle \\
& < \subseteq R;V \text{ and } < \subseteq V;R^\sim \\
\Leftrightarrow & \quad \langle \text{taking the converse, } <^\sim = > \rangle \\
& < \subseteq R;V \text{ and } > \subseteq R;V \\
\Leftrightarrow & \quad \langle \text{Boolean algebra} \rangle \\
& < \cup > \subseteq R;V \\
\Rightarrow & \quad \langle \text{since } S \text{ has } \perp \text{ and } \top, \text{ relation } < \cup > \text{ is total,} \\
& \quad \text{except when } \top = \perp \rangle \\
& R \text{ is total if } \top \neq \perp.
\end{aligned}$$

In sum, all this means that Conditions 22 are not useful for studying the reflexive points of *partial* relations.

For *total* relations, we have concluded the corresponding Section 3.3 with the remark that Condition 4(c) in Theorem 5 cannot be relaxed to a weaker combination of some of 4(a,b,d). Because Conditions 22(a,b,d) are stronger than 4(a,b,d) (see Theorem 16), one might conjecture that 4(c) (equivalently, 22(c)) could be weakened to a combination of some of 22(a,b,d). However, this is not the case. The lattice $\{\perp, \mathbf{a}, \mathbf{b}, \top\}$, with ordering $\perp < \mathbf{a} < \top$ and $\perp < \mathbf{b} < \top$, and the relation

$$R := \{(\perp, \mathbf{a}), (\perp, \mathbf{b}), (\mathbf{a}, \mathbf{a}), (\mathbf{a}, \mathbf{b}), (\mathbf{b}, \mathbf{a}), (\mathbf{b}, \mathbf{b}), (\top, \mathbf{a}), (\top, \mathbf{b})\} \quad (29)$$

(see Appendix A(l)) form an example of a total relation that satisfies all of 22(a,b,d) and that has no least reflexive point.

7. Conclusion

This paper provides a first survey on the structure of the set of reflexive points of relations on complete lattices. We have exhibited suitable adaptations of the notion of monotonicity of a total function to the relational case. It may come as a certain surprise that the direct relational formulations of monotonicity of a total function are of no use in this setting and have to be replaced by new conditions. With the help of these we have shown an analogue of Tarski's classical result [8] on existence and lattice structure of the reflexive points. Another advantage of the new conditions is that they are checked manually much more easily than the relational ones.

What is still missing is a suitable generalization of the notion of continuity and, following that, an investigation when least reflexive elements can be obtained by iteration as in Kleene's Theorem [6] (the process being also already mentioned in [8]).

Another open question in connection with iteration (see Section 2) is whether there are (not too strong) conditions guaranteeing the existence of a least reflexive point when the strict ordering is progressively finite and the relation is inflationary. Moreover, which additional conditions ensure that any path by R from \perp leads to this least reflexive point? We conclude this paper with a last counter-example showing that Conditions 4(a,b,d) are not sufficient to guarantee this.

Consider again the relation R from (28) (see Appendix A(m)). That relation is inflationary and satisfies 4(a,b,d), the strict ordering is progressively finite, there is a least and a greatest reflexive point, but there is a path from \perp to \top that does not go through the least reflexive point, which is \mathbf{a} .

Acknowledgements

We are grateful to the referees for their helpful remarks, in particular to Oege de Moor for his hint to look at Condition 22(a). Valuable comments were also provided by Thorsten Ehm and Georg Struth.

References

1. R. C. Backhouse *et al.* Fixed point calculus. *Inform. Proc. Letters*, 53:131–136, 1995.
2. J. Cai and R. Paige. Program derivation by fixed point computation. *Science of Computer Programming*, 11:197–261, 1989.
3. J. Cai and R. Paige. Languages polynomial in the input plus output. *Second International Conference on Algebraic Methodology and Software Technology (AMAST'91)*, pages 287–300, Springer, London, 1992.
4. B. A. Davey and H. A. Priestley. *Introduction to Lattices and Order*. Cambridge Mathematical Textbooks, Cambridge University Press, Cambridge, 1990.
5. J. Desharnais and Bernhard Möller. Least reflexive points of relations. Research report 2002–13, Institut für Informatik, Universität Augsburg, June 2002.
6. S. C. Kleene: *Introduction to Metamathematics*. Van Nostrand, New York, 1952.
7. G. Schmidt and T. Ströhlein. *Relations and Graphs*. EATCS Monographs in Computer Science, Springer-Verlag, Berlin, 1993.
8. A. Tarski. A lattice-theoretical fixpoint theorem and its applications. *Pacific Journal of Mathematics*, 5:285–309, 1955.

Appendix

A. EXAMPLES AND COUNTEREXAMPLES

This section contains diagrams of some of the lattices and relations presented in the paper. Each lattice $(S, \sqcap, \sqcup, \perp, \top, \leq)$ is described by the Hasse diagram of its corresponding partial order, with boxes representing vertices (elements of S) and straight lines representing edges. The relation R on the lattice is represented by arrows linking the boxes. Each box contains three pieces of information:

- on the left is the element $s \in S$;
- on the bottom right is $\sqcap sR$;
- on the top right is $\sqcup sR$.

The following information is given under each diagram:

- the list of properties among $4(a,b,c,d)$ that hold for this diagram;
- the list of properties among $22(a,b,c,d)$ that hold for this diagram;
- the word “Inflationary”, if the relation is inflationary;
- the equation where the relation is defined.

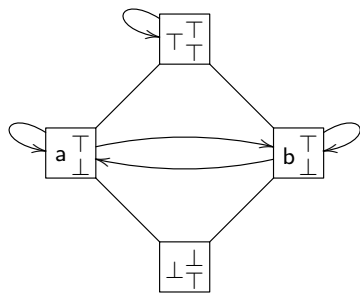

a) 4(b,c,d)
22(c,d)
Equation 6



b) 4(a,c,d)
22(a,c,d)
Equation 7

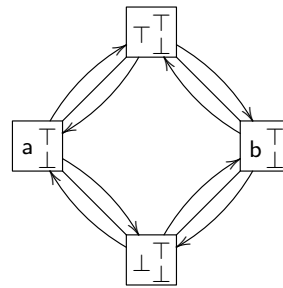

c) 4(a,b,d)
22(b)
Equation 8

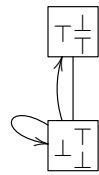

d) 4(a,b,c)
22(a,c)
Equation 9

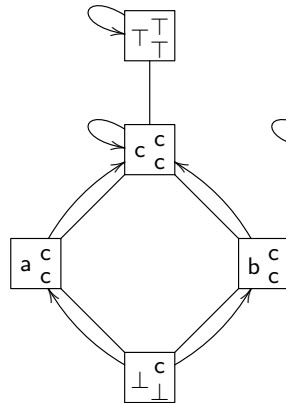

e) 4(a,b,c,d)
22(a,b,c,d)
Inflationary
Equation 13

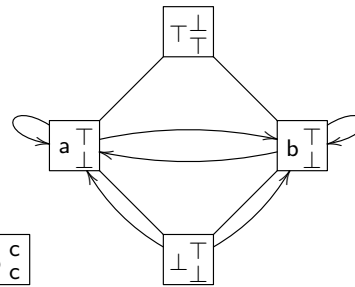

f) 4(a,b)
22(a)
Equation 15

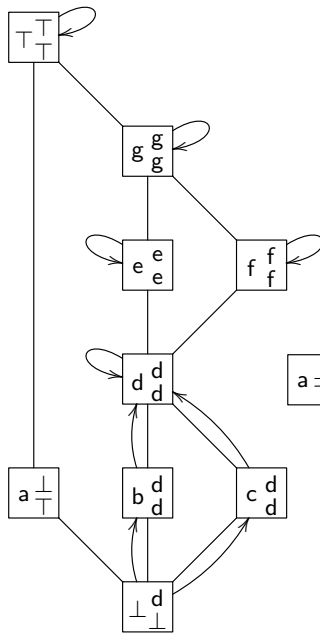

g) 4(a,b,c)
22(c)
Equation 16

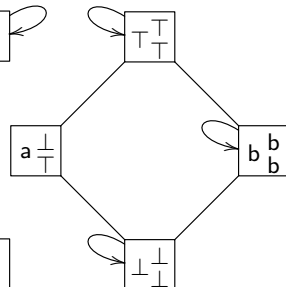

h) 4(a,b,c,d)
22(c)
Equation 17

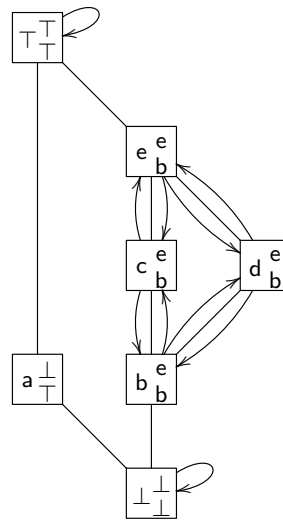

i) 4(a,b,d)
Equation 18



⋮



j) 4(a,b,c,d)
22(a,b,c,d)
Inflationary
Equation 19



m) 4(a,b,d)
22(a,b,d)
Inflationary
Equation 28

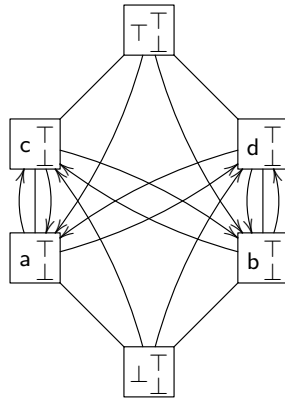

k) 4(a,b,d)
Equation 27

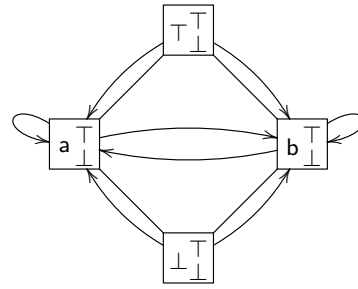

l) 4(a,b,d)
22(a,b,d)
Equation 29

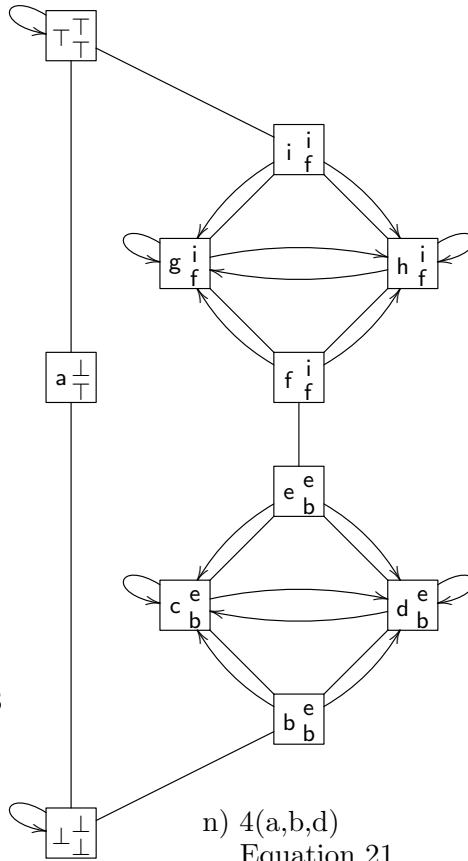

n) 4(a,b,d)
Equation 21

B. COMBINATIONS OF PROPERTIES

Here are examples of lattices and relations showing all possible combinations of Conditions 4 and all possible combinations of Conditions 22. For all but one example, there is no need of sophisticated lattices: two linear orders suffice! Each example uses a minimal lattice, except possibly relation (p) in the tables below; also, the trivial lattice with $\top = \perp$ with the empty or the universal relation could be used instead of (j) to illustrate 4(a,b,c,d) and 22(a,b,c,d).

The labels of the following relations correspond to those of the diagrams that follow the presentation of the relations.

1. Lattice $\{\perp, \top\}$ with ordering $\perp < \top$.

	Relation	Properties
(a)	$\{(\perp, \top), (\top, \perp)\}$	None
(b)	$\{(\perp, \perp), (\perp, \top), (\top, \perp)\}$	4(a,b), 22(a,b)
(c)	$\{(\perp, \top)\}$	4(a,c), 22(a,c)
(d)	$\{(\perp, \top), (\top, \perp), (\top, \top)\}$	4(b,d), 22(b,d)
(e)	$\{(\top, \perp)\}$	4(c,d), 22(c,d)
(f)	$\{(\perp, \perp), (\perp, \top)\}$	4(a,b,c), 22(a,c)
(g)	$\{(\perp, \perp), (\perp, \top), (\top, \perp), (\top, \top)\}$	4(a,b,d), 22(a,b,d)
(h)	\emptyset	4(a,c,d), 22(a,c,d)
(i)	$\{(\top, \perp), (\top, \top)\}$	4(b,c,d), 22(c,d)
(j)	$\{(\perp, \perp), (\top, \top)\}$	4(a,b,c,d), 22(a,b,c,d)

2. Lattice $\{\perp, a, \top\}$ with ordering $\perp < a < \top$.

	Relation	Properties
(k)	$\{(\perp, \perp), (\perp, \top), (a, a)\}$	4(a), 22(a)
(l)	$\{(\perp, a), (\perp, \top), (a, \perp), (a, a), (\top, a)\}$	4(b), 22(b)
(m)	$\{(a, \perp), (a, a)\}$	4(c), 22(c)
(n)	$\{(a, a), (\top, \perp), (\top, \top)\}$	4(d), 22(d)
(o)	$\{(\perp, \perp), (\perp, a), (\top, a), (\top, \top)\}$	4(b,c), 22(c)

3. Lattice $\{\perp, a, b, c, d, \top\}$ with the ordering $\perp < a < c < \top$ and $\perp < b < d < \top$.

	Relation	Properties
(p)	$\{(\perp, \perp), (a, a), (a, b), (c, c), (c, d), (\top, \top)\}$	4(a,d)

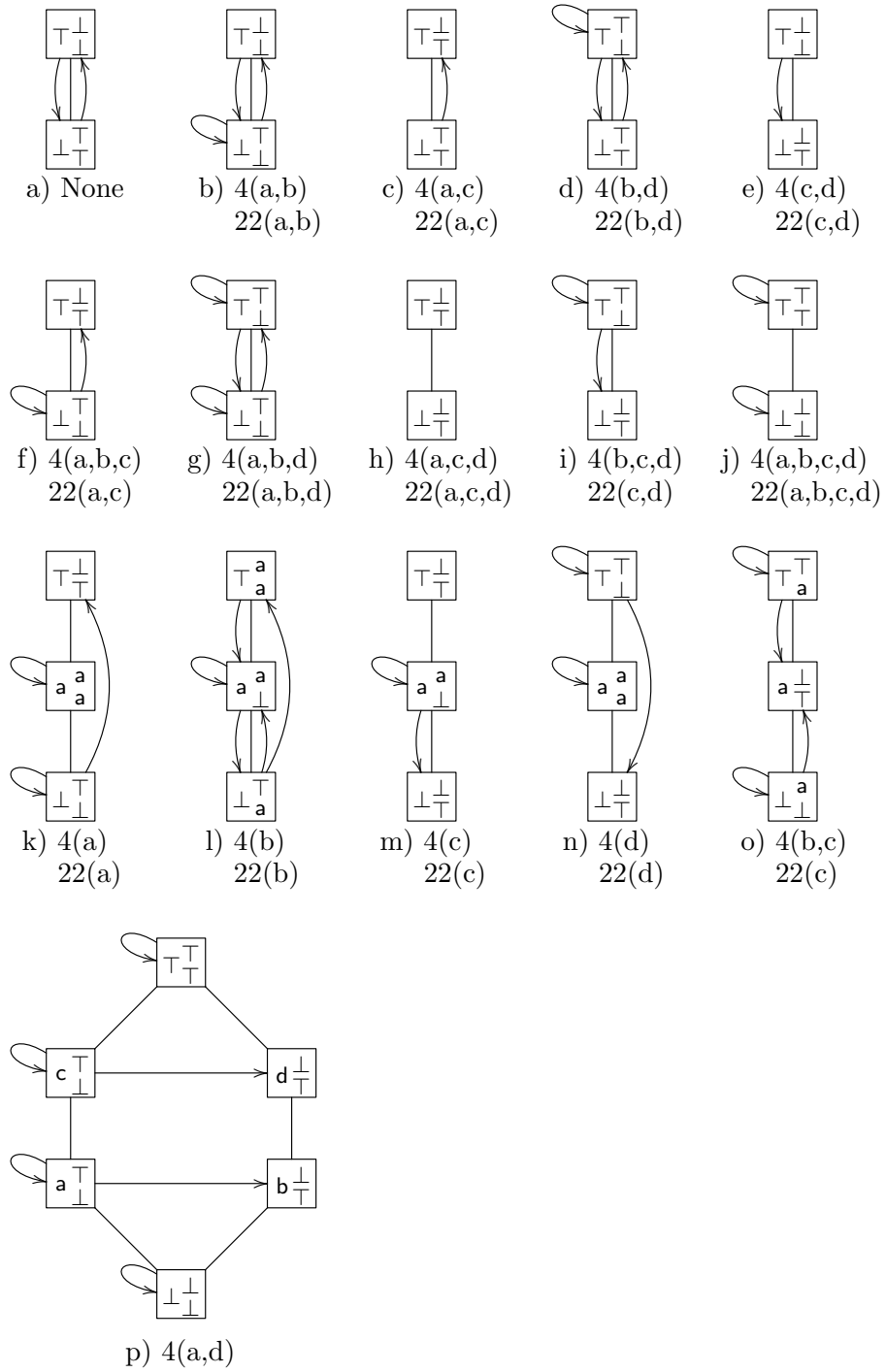

C. SUPPLEMENTARY PROOFS

We prove the implications stated in Theorem 16:

1. $<;R \subseteq R;\leq$
 - \Leftrightarrow $\langle \text{definitions} \rangle$
 - $\forall(x, s :: \exists(y :: x < y \text{ and } yRs) \Rightarrow \exists(t :: xRt \text{ and } t \leq s))$
 - \Leftrightarrow $\langle \text{export leftmost inner quantifier} \rangle$
 - $\forall(x, s, y :: x < y \text{ and } yRs \Rightarrow \exists(t :: xRt \text{ and } t \leq s))$
 - \Leftrightarrow $\langle \text{rearrangement and definition of image} \rangle$
 - $\forall(x, y, s :: x < y \text{ and } s \in yR \Rightarrow \exists(t :: t \in xR \text{ and } t \leq s))$
 - \Leftrightarrow $\langle \text{currying} \rangle$
 - $\forall(x, y, s :: x < y \Rightarrow (s \in yR \Rightarrow \exists(t :: t \in xR \text{ and } t \leq s)))$
 - \Leftrightarrow $\langle \text{import outer quantifier} \rangle$
 - $\forall(x, y :: x < y \Rightarrow \forall(s :: s \in yR \Rightarrow \exists(t :: t \in xR \text{ and } t \leq s)))$
 - \Rightarrow $\langle \text{definition of } \sqcap \text{ and } \sqcup \rangle$
 - $\forall(x, y : x < y : \sqcap xR \leq \sqcap yR)$
2. $< \subseteq R;\leq;R^\circ$
 - \Leftrightarrow $\langle \text{definitions} \rangle$
 - $\forall(x, y :: x < y \Rightarrow \exists(s, t :: xRs \text{ and } s \leq t \text{ and } yRt))$
 - \Leftrightarrow $\langle \text{rearrangement and definition of image} \rangle$
 - $\forall(x, y :: x < y \Rightarrow \exists(s, t :: s \in xR \text{ and } t \in yR \text{ and } s \leq t))$
 - \Rightarrow $\langle \text{definition of } \sqcap \text{ and } \sqcup \rangle$
 - $\forall(x, y : x < y : \sqcap xR \leq \sqcup yR)$
3. $R^\circ;<;R \subseteq \leq$
 - \Leftrightarrow $\langle \text{definitions} \rangle$
 - $\forall(s, t :: \exists(x, y :: xRs \text{ and } x < y \text{ and } yRt) \Rightarrow s \leq t)$
 - \Leftrightarrow $\langle \text{export inner quantifier} \rangle$
 - $\forall(s, t, x, y :: xRs \text{ and } x < y \text{ and } yRt \Rightarrow s \leq t)$
 - \Leftrightarrow $\langle \text{rearrangement} \rangle$
 - $\forall(x, y, s, t :: x < y \text{ and } xRs \text{ and } yRt \Rightarrow s \leq t)$

$$\begin{aligned}
&\Leftrightarrow \langle \text{definition of image} \rangle \\
&\quad \forall(x, y, s, t :: x < y \text{ and } s \in xR \text{ and } t \in yR \Rightarrow s \leq t) \\
&\Leftrightarrow \langle \text{currying} \rangle \\
&\quad \forall(x, y, s, t :: x < y \Rightarrow (s \in xR \text{ and } t \in yR \Rightarrow s \leq t)) \\
&\Leftrightarrow \langle \text{import outer quantifier} \rangle \\
&\quad \forall(x, y :: x < y \Rightarrow \forall(s, t :: s \in xR \text{ and } t \in yR \Rightarrow s \leq t)) \\
&\Leftrightarrow \langle \text{definition of } \sqcap \text{ and } \sqcup \rangle \\
&\quad \forall(x, y : x < y : \sqcup xR \leq \sqcap yR)
\end{aligned}$$

4. This is proved completely dually to 1.